

ASSEMBLY INTRUCTION

JULITA 2200
2200 x 900 x H730 mm



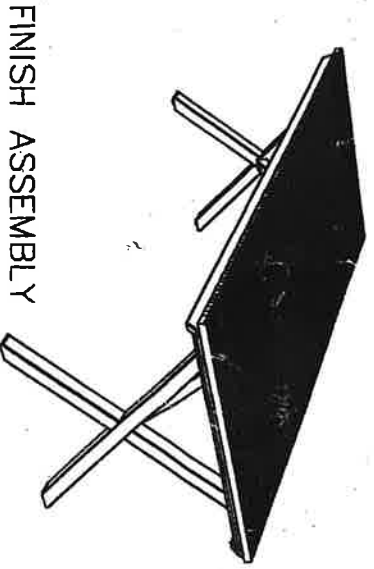
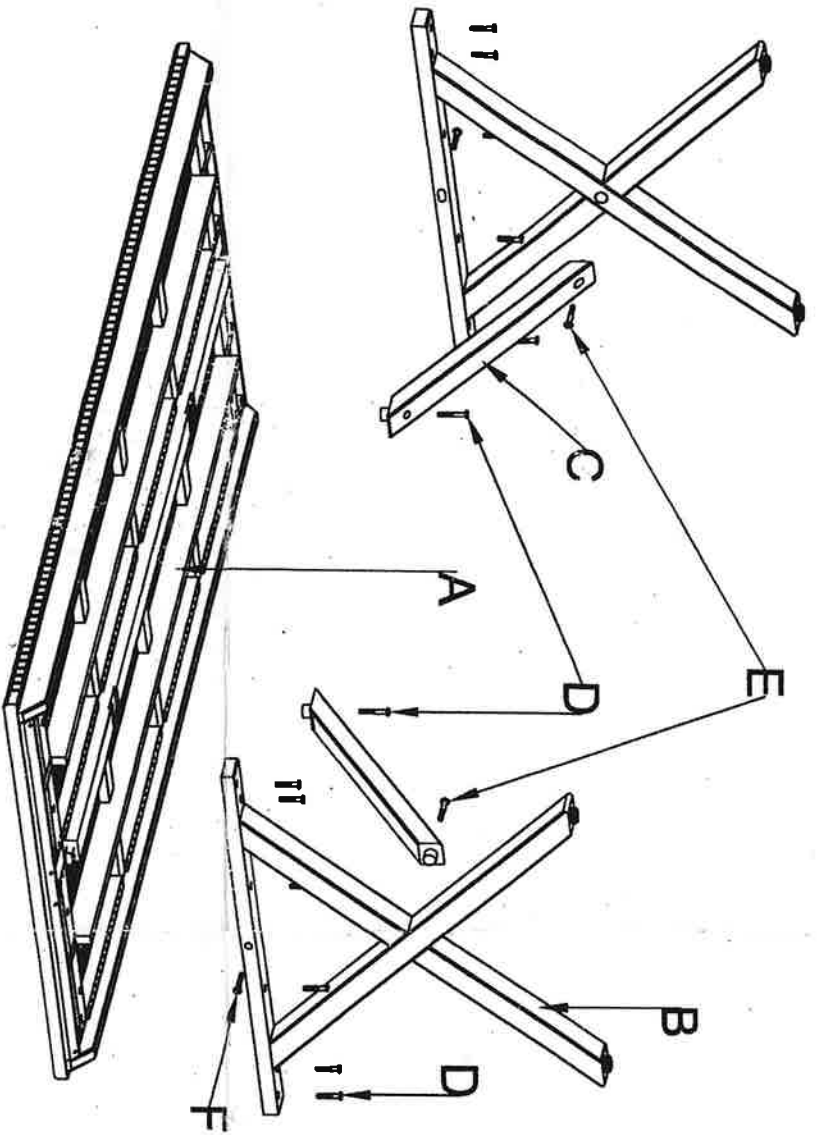

BUYER:
BRAFAB

MATERIAL OF PART

POST. QTY. COMPONENT

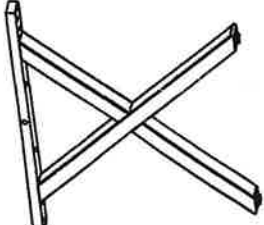

FINISH ASSEMBLY

POST. QTY.	COMPONENT
A 1	
B 2	
C 2	
D 14	 40 mm
E 2	 50 mm
F 2	 60 mm
L.5	